



BT 188 T BT 288

twister



BT 188 T BT 288

Superb twisting quality and high speed – these are the hallmarks of the bt 188 T and bt 288 semiautomatic twisting machines from Komax. They are also easy to operate, attractively priced and guarantee fantastic performance. The bt 288 features two twisting lines, making it the perfect solution for efficient wire set processing – even where large quantities are involved. When combined with the new optional spot taping unit, the bt 188 T binds both wire ends using cloth or PVC tape.

Fast, flexible and easy to use

- Simple, intuitive operation
- High production speed with one operator
- Process parameters calculated in relation to final product

High quality and excellent process reliability

- Stringent quality assessments before production approval
- Outstanding processing quality
- Reliable results at all times

Key highlights of the bt 188 T

- Able to automatically bind both wire ends with cloth or PVC tape as option
- Able to twist three or four wires without any pitch errors as option

Key highlight of the bt 288

- Two twisting lines in a single machine

TWO HIGHLY EFFICIENT
**TWISTING
SPECIALISTS.**



01

01
Intuitive TopTouch
user interface.



PERFECT QUALITY WITH A TWIST



bt 188 T – maximum precision for excellent process reliability

The bt 188 T is capable of twisting two to four wires with excellent results. The parameters can be adjusted as required, which the machine then uses to automatically calculate the required cut length. For example, you can vary the final twisted length, the pitch length, the wire cross section, the outer wire diameter and the open ends. This minimizes the amount of test material consumed when setting up a new product and ensures that everything is ready for production in no time. The intuitive TopTouch user interface makes the system extremely easy to work with. New products can be programmed and existing ones loaded quick and simple. Up to 1200 different articles can be stored.

Outstanding options available with the bt 188 T

- A spot taping unit can be integrated to enable precise and automatic binding. This processes both wire ends simultaneously.
- It is also possible to integrate a high-precision multi-conductor twisting unit that is capable of handling three or four wires. This produces perfect results without any pitch errors. The uniform pitch length and high level of consistency across the entire twisted wire length guarantees excellent performance every time.

Options at a glance

- Integrated taping unit
- Flat grippers for twisting three or four wires
- Highly precise multi-conductor twisting
- Up to three extensions (machine can be extended from 3 m up to 12 m)
- Bottom/top feed tray
- Table base
- Foot pedal
- Spacer holder for short twisted lengths
- Moving operating button for gripper closing



Precise multi-conductor twisting option.



Optional fully automatic spot taping unit.

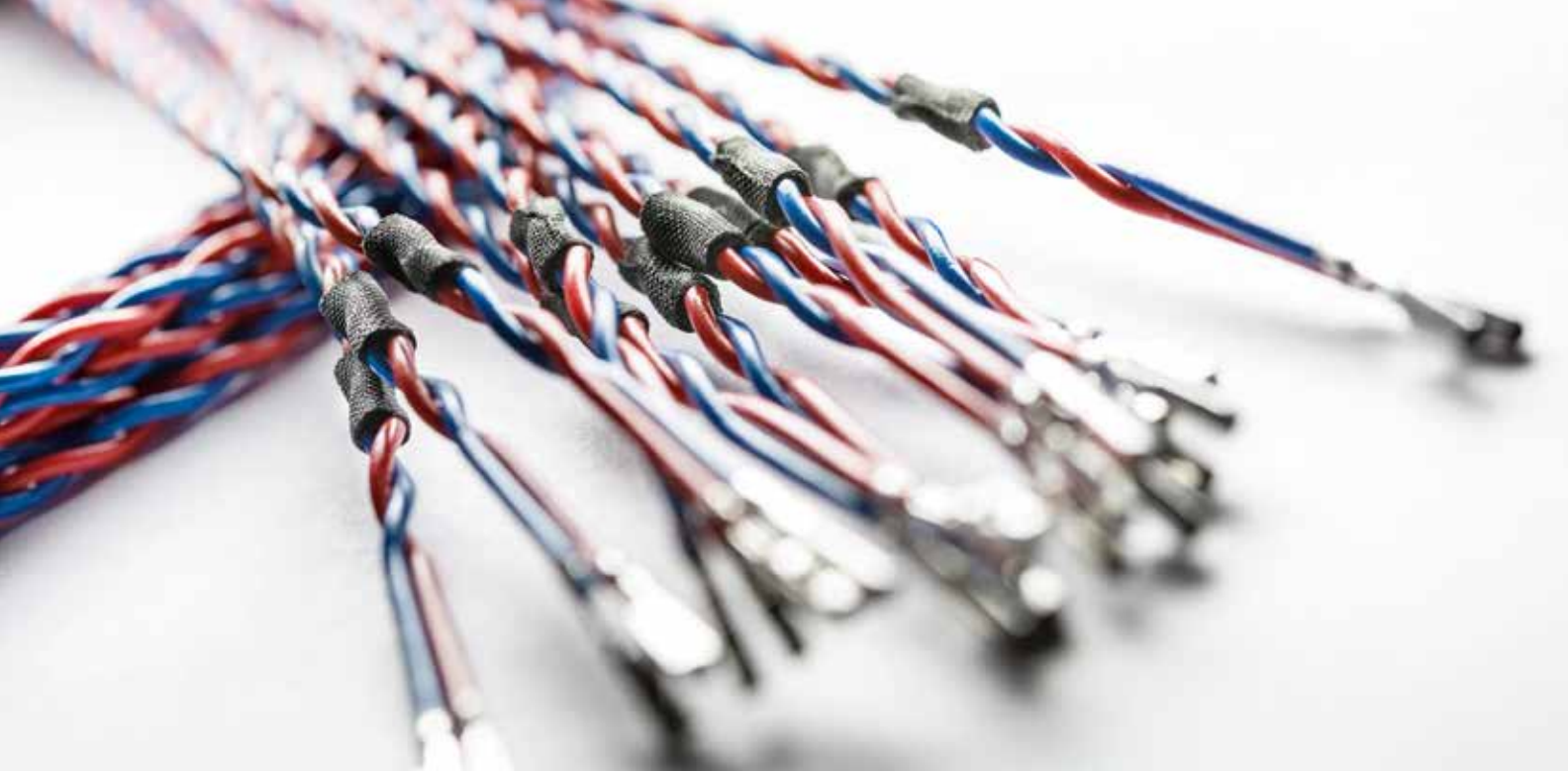

New and unique: fully automatic spot taping unit

The integrated spot taping unit is only available for the bt 188 T. The unit binds small tapes of cloth or PVC to the twisted cable ends to avoid unwinding during transport and assembly. Customers also have the option of upgrading their existing systems with this market innovation from Komax.

- Automatic taping
- Taping unit position kept constant in relation to center of wire
- Both wire ends taped simultaneously

Increased quality requirements

There is a constant increase in the number of communication wires used in cars and in the level of quality demanded. However, the unwanted enlargement of open wire ends is impairing data transmission quality. The way to overcome this problem is to bind the wire ends. The automatic taping process constantly and accurately maintains the same position and ensures that the open end remains compact and within the defined specifications.

Technical data for bt 188 T spot taping unit

Pneumatic connection	6 bar (87 psi)
Bundle diameter	2 – 6 mm (0.078 – 0.236 in.)
Tape width	9 mm (0.354 in.)
Tape roll core diameter	38.1 mm (1.5 in.) / 76.2 mm (3 in.)
Tape materials	Cloth and PVC
Dimensions (H x W x D)	190 x 210 x 470 mm (7.48 x 8.27 x 18.5 in.)
Approx. weight	5 kg (11 lbs)

PRODUCTIVITY DOUBLED





bt 288 – for maximum productivity

The Komax bt 288 is based on the proven and tested technology of the bt 188 T. With a second twisting line, this semi-automatic twisting machine offers virtually double the production efficiency without any reduction in processing quality. And with its small footprint, it takes up hardly any space at all. The bt 288 calculates the cut length automatically and – in conjunction with the flat gripper option – can be used to twist three or four wires. The intuitive software (operated via touchscreen) enables you to save the twisting parameters.

Options at a glance

- Flat grippers for twisting three or four wires
- Up to three extensions (machine can be extended from 3 m up to 12 m)
- Bottom/top feed tray
- Table base
- Foot pedal
- Spacer holder for short twisted lengths

bt 188 T / bt 288 machine layout

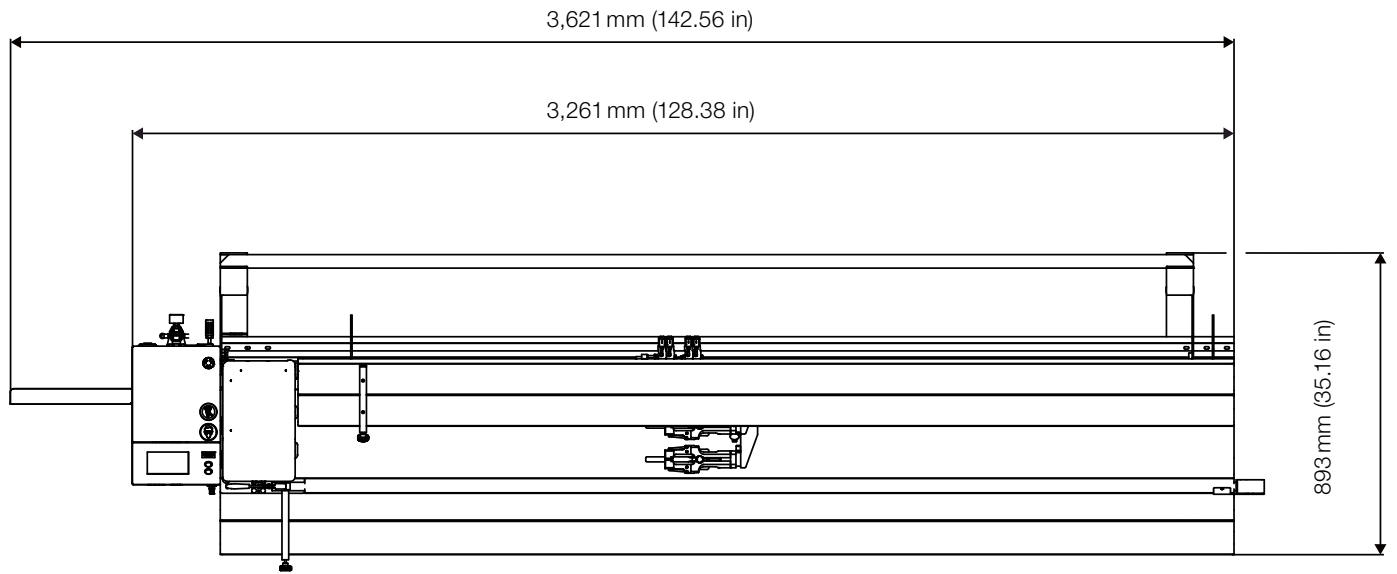

Height: 1,435 mm (56.49 in)



Technical data for bt 188 T and bt 288

	bt 188 T	bt 288
Wire cross-sections	2 × 0.08 – 2 × 4.0 mm ² (2 × AWG 28 – 2 × 11) Optional: 3 × 0.08 – 3 × 2.5 mm ² (3 × AWG 28 – 3 × 14) 4 × 0.08 – 4 × 2.5 mm ² (4 × AWG 28 – 4 × 14)	
Pitch length	8 – 50 mm (± 5 mm*) (0.31 – 1.97 in)	
Length of open ends	Side 1: 25 – 190 mm (0.98 – 7.48 in), adjustable Side 2: 25 – 85 mm (0.98 – 3.35 in), adjustable	
Difference between open ends	0 – 60 mm (0 – 2.36 in)	
Final twisted lengths	Approx. 200 – 2'300 mm (approx. 7.87 – 90.55 in)**/** Approx. 200 – 11'300 mm (approx. 7.87 – 444.9 in)**/** optional	
Min. wire length with highly precise multi-conductor twisting option	300 mm (11.81 in)	Not available
Min. wire length with spot taping unit option	700 mm (27.56 in.)	Not available
Electrical connection	115/230 V, 50/60 Hz	
Compressed air supply	4 – 6 bar (58 – 87 psi)	
Weight of basic module	Approx. 95 kg (209 lbs)	Approx. 110 kg (243 lbs)
Weight base	Approx. 45 kg (99 lbs)	
Weight of extension module	Approx. 65 kg (143 lbs)	
Production output	Approx. 350 pcs/h**** Approx. 250 pcs/h**** (with highly precise multi-conductor twisting option)	Approx. 600 pcs/h****
Noise level	<80 dB	











* Dependent on process parameters and process speed

** Final twisted length dependent on material and pitch length

*** With option for two short twisted wires; minimum wire length > 160 mm (6.3 in)

**** Set values: Cable: FLYR 2 × 0.50 mm² (AWG 30), pitch: 20 mm (0.8 in), final twisted length: 1,000 mm (39.4 in), open end on left and right: 30 mm (1.2 in), overtwist: 25 %

Processing examples

Initial situation	Final product
	
	
	
	
	

Komax Wire – industry leader today and in the future

As the pioneer and market leader in the field of automated wire processing, Komax Wire provides its customers with innovative and sustainable solutions for any situation that calls for precise contact connections. Komax Wire manufactures machinery and equipment for various industries, catering for every conceivable degree of automation and customization. Its range of quality tools, test systems and intelligent networking solutions complete the portfolio, and ensure safe and efficient production. The Swiss company, which has operations all over the world, develops and manufactures its products at various locations. Its extensive distribution and service network supports customers locally in more than 60 countries through standardized service processes, while ensuring the ongoing availability and value of these customers' investments once the equipment has been put into operation. The Swiss company Komax Wire is part of the international Komax Group, which employs approximately 1600 people.



Market segments

Komax Wire offers outstanding competence and solutions for various areas of application and draws on them to generate the desired value-added for the entire process and optimize economic efficiency in line with customer requirements. The main markets of Komax Wire are as follows: automotive, aerospace, industrial and telecom & datacom. With this breadth of experience, customers obtain expert knowledge for process optimization and access to the latest technologies.



Komax AG
Industriestrasse 6
CH – 6036 Dierikon
Phone +41 41 455 04 55
Fax +41 41 450 15 79

komax WIRE
komaxwire.com